

(NC) 5 Passivity / 5.1 Memoryless Functions

1. (Passivity) It provides us with a useful tool for the analysis of nonlinear systems related to Lyapunov stability.
2. (Memoryless Function) It is called memoryless function when the input u affects the output y directly w/o dynamic relation.

$$y = h(t, u) \quad (41)$$

3. Consider the resistor with the voltage u as input and the current y as output

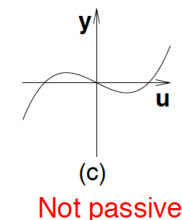
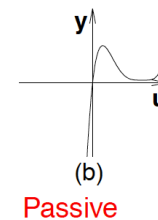
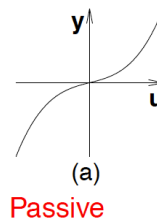
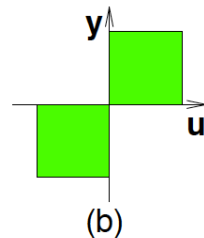
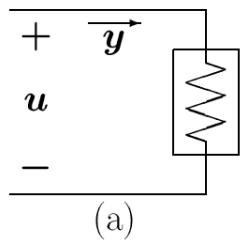

- Power flow into the system: (scalar case) $uy \Rightarrow u^T y$ (vector case)
- The system is passive if the inflow of power is nonnegative,

$$uy \geq 0 \quad \forall (u, y) \quad \Rightarrow \quad u^T y = u^T h(t, u) \geq 0 \quad \forall (t, u) \quad (42)$$

- For $u^T h(t, u) \geq 0$, the memoryless function $h(t, u) = Ku$ belongs to the sector $K \in [0, \infty]$.
- Especially the system is called lossless if $u^T y = 0$
- Geometrically, it means that the $u - y$ curve must lie in the first and third quadrants.

4. (Definition 5.1) The system $y = h(t, u)$ is

- passive if $u^T y \geq 0, \forall (u, y)$
- lossless if $u^T y = 0, \forall (u, y)$
- input strictly passive if $u^T y \geq u^T \varphi(u) > 0, \forall u \neq 0$
- output strictly passive if $u^T y \geq y^T \rho(y) > 0, \forall y \neq 0$.

5. (Sector Condition) consider a scalar function $y = h(t, u)$ satisfying the inequalities

$$\begin{aligned} \alpha u^2 \leq uh(t, u) \leq \beta u^2 &\Rightarrow [h(t, u) - \alpha u]u \geq 0 \quad \text{and} \quad [h(t, u) - \beta u]u \leq 0 \\ [h(t, u) - \alpha u][h(t, u) - \beta u]u^2 \leq 0 &\Rightarrow \therefore [h(t, u) - \alpha u][h(t, u) - \beta u] \leq 0 \quad \forall (t, u) \end{aligned}$$

where we say that $h(t, u)$ belongs to a sector $[\alpha, \beta]$. The following figure shows the sector $[\alpha, \beta]$ for $\beta > 0$ and different sign of α .

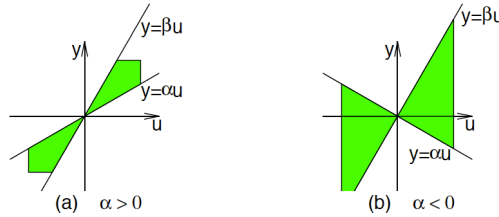

6. (Matrix-Vector Representation of Sector Condition) Taking

$$K_1 = \text{diag}(\alpha_1, \alpha_2, \dots, \alpha_m)$$

$$K_2 = \text{diag}(\beta_1, \beta_2, \dots, \beta_m)$$

the sector condition $[K_1, K_2]$ in the matrix-vector form can be easily seen that

$$[h(t, u) - \alpha u][h(t, u) - \beta u] \leq 0 \quad \Rightarrow \quad [h(t, u) - K_1 u]^T [h(t, u) - K_2 u] \leq 0 \quad \forall (t, u) \quad (43)$$

7. (Transformation of Sector Condition) A function in the sector $[K_1, K_2]$ can be transformed into a function in the sector $[0, \infty]$ by input feedforward followed by output feedback. Let $K = K_2 - K_1$, then we have $u_2 = Ku = (K_2 - K_1)u = u_1 + y_1$ and $y_1 = h(t, u) - K_1u$

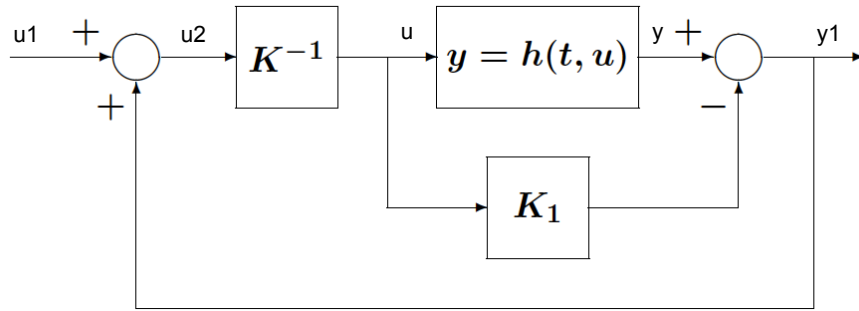

$$[h(t, u) - K_1u]^T [h(t, u) - K_2u] \leq 0$$

$$y_1^T [h(t, u) - K_2u] \leq 0$$

$$y_1^T [y_1 + K_1u - K_2u] \leq 0$$

$$y_1^T [y_1 - Ku] \leq 0$$

$$y_1^T (-u_1) \leq 0$$

$$\therefore u_1^T y_1 \geq 0 \quad \forall (u_1, y_1)$$

8. (Definition 5.2) A memoryless function $h(t, u)$ belongs to the sector

- $[K_1, K_2]$ with $K = K_2 - K_1 = K^T > 0$, if $[h(t, u) - K_1u]^T [h(t, u) - K_2u] \leq 0 \quad \forall (t, u)$
- $[0, K_2]$ with $K_2 = K_2^T > 0$, if $h^T(t, u)[h(t, u) - K_2u] \leq 0 \quad \forall (t, u)$
- $[K_1, \infty]$, if $u^T [h(t, u) - K_1u] \geq 0 \quad \forall (t, u)$
- $[0, \infty]$, if $u^T h(t, u) \geq 0 \quad \forall (t, u)$

(NC) 5.2 State Models

1. Let us extend the concept of passivity into the dynamical system represented by

$$\dot{x} = f(x, u) \qquad y = h(x, u) \qquad (44)$$

where f is locally Lipschitz, h is continuous, $f(0, 0) = 0$, and $h(0, 0) = 0$.

2. (Passivity 1) The system is passive if the energy absorbed by the system (the energy supplied into the system) is greater than or equal to the change in the energy stored in the system over any time period $[0, t]$; that is,

$$\text{the supplied energy: } \int_0^t u(s)y(s)ds \geq V(x(t)) - V(x(0)) \quad \text{:change of the stored energy} \quad (45)$$

where $V(x)$ is the energy stored in the system

3. (Passivity 2) The system is passive if the power flow into the system must be greater than or equal to the rate of change of the energy stored in the system. Thus we have

$$u(t)y(t) \geq \dot{V}(x(t)) \quad \forall t \geq 0 \qquad (46)$$

4. (Example 5.1) Consider the RLC circuit with linear inductor/capacitor and three nonlinear resistors. Check the passivity of the state model?

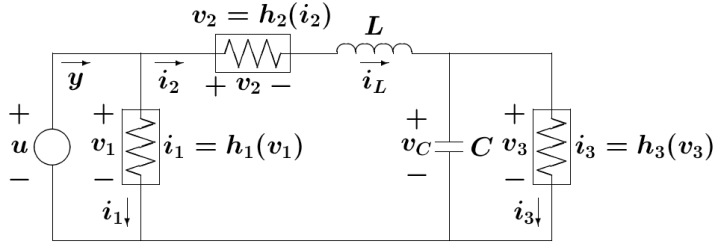

$$\begin{aligned} L \frac{di_L}{dt} &= u - v_2 - v_C = u - h_2(i_L) - v_C \\ C \frac{dv_C}{dt} &= i_L - i_3 = i_L - h_3(v_C) \\ y &= i_L + i_1 = i_L + h_1(u) \end{aligned}$$

- Let us denote the current $x_1 \triangleq i_L$ through the inductor and the voltage $x_2 \triangleq v_C$ across the capacitor, then we have the state model as follows:

$$L\dot{x}_1 = u - h_2(x_1) - x_2 \quad C\dot{x}_2 = x_1 - h_3(x_2) \quad y = x_1 + h_1(u)$$

- Since the energy stored in the network is $V(x) = \frac{1}{2}Lx_1^2 + \frac{1}{2}Cx_2^2$, we can get \dot{V}

$$\begin{aligned} \dot{V}(x) &= Lx_1\dot{x}_1 + Cx_2\dot{x}_2 = x_1(u - h_2(x_1) - x_2) + x_2(x_1 - h_3(x_2)) = x_1u - x_1h_2(x_1) - x_2h_3(x_2) \\ &= (x_1 + h_1(u))u - uh_1(u) - x_1h_2(x_1) - x_2h_3(x_2) = uy - uh_1(u) - x_1h_2(x_1) - x_2h_3(x_2) \end{aligned}$$

$$\therefore uy = \dot{V} + uh_1(u) + x_1h_2(x_1) + x_2h_3(x_2)$$

- If h_1, h_2, h_3 are passive, then $uy \geq \dot{V}$ and the system is passive by Eq. (46)
- If $h_1 = h_2 = h_3 = 0$, then $uy = \dot{V}$ and the system is lossless b/c no dissipation energy
- If h_2, h_3 are passive, then $uy \geq \dot{V} + uh_1(u)$. If $uh_1(u) > 0 \quad \forall u \neq 0$, the system is input strictly passive by Definition 5.1
- If $h_1 = 0$ and h_3 is passive, then $uy \geq \dot{V} + yh_2(y)$. If $yh_2(y) > 0 \quad \forall y \neq 0$, the system is output strictly passive by Definition 5.1
- If h_1 is passive, then $uy \geq \dot{V} + x_1h_2(x_1) + x_2h_3(x_2)$. If $x_1h_2(x_1) + x_2h_3(x_2) > 0 \quad \forall (x_1, x_2) \neq 0$, the system is state strictly passive, or simply strictly passive.

5. (Definition 5.3) The system described by $\dot{x} = f(x, u)$ and $y = h(x, u)$ is passive if \exists a continuously differentiable positive semidefinite function $V(x)$ (called the storage function) \ni

$$u^T y \geq \dot{V} \quad \forall (x, u) \quad (47)$$

Moreover, it is

- lossless, if $u^T y = \dot{V}$
- input strictly passive, if $u^T y \geq \dot{V} + u^T \varphi(u)$ and $u^T \varphi(u) > 0, \quad \forall u \neq 0$
- output strictly passive, if $u^T y \geq \dot{V} + y^T \rho(y)$ and $y^T \rho(y) > 0, \quad \forall y \neq 0$
- strictly passive (or state strictly passive), if $u^T y \geq \dot{V} + \psi(x)$ and $\psi(x) > 0, \quad \forall x \neq 0$

6. (Example 5.2) Check the passivity of following systems ?

(where $h \in [0, \infty]$ and $uh(u) > 0 \quad \forall u \neq 0$ and $yh(y) > 0 \quad \forall y \neq 0$)

$$(a) \quad \begin{aligned} \dot{x} &= u \\ y &= x \end{aligned}$$

$$(b) \quad \begin{aligned} \dot{x} &= u \\ y &= x + h(u) \end{aligned}$$

$$(c) \quad \begin{aligned} \dot{x} &= -h(x) + u \\ y &= x \end{aligned}$$

(a) Take the storage function $V(x) = \frac{1}{2}x^2$, then we have $\dot{V} = x\dot{x} = xu = uy \Rightarrow uy = \dot{V}$
Thus the system is lossless.

(b) Since $\dot{V} = x\dot{x} = xu = (y - h(u))u = uy - uh(u) \Rightarrow uy = \dot{V} + uh(u)$,
thus the system is input strictly passive.

(c) Since $\dot{V} = x\dot{x} = x(-h(x) + u) = y(-h(y) + u) = uy - yh(y) \Rightarrow uy = \dot{V} + yh(y)$,
thus the system is output strictly passive.

7. (Example 5.3) Check the passivity of following systems ?

(where $h \in [0, \infty]$ and $xh(x) > 0 \quad \forall x \neq 0$)

$$(a) \quad \begin{aligned} \dot{x} &= u \\ y &= h(x) \end{aligned}$$

$$(b) \quad \begin{aligned} a\dot{x} &= -x + u \\ y &= h(x) \end{aligned}$$

(a) Take the storage function $V(x) = \int_0^x h(\sigma)d\sigma$, then we have $\dot{V} = h(x)\dot{x} = yu \Rightarrow uy = \dot{V}$
Thus the system is lossless.

(b) Take the storage function $V(x) = a \int_0^x h(\sigma)d\sigma$, then we have

$$\dot{V} = ah(x)\dot{x} = h(x)(-x + u) = h(x)u - xh(x) = uy - xh(x) \Rightarrow uy = \dot{V} + xh(x)$$

Thus the system is strictly passive.

8. (Example 5.4) Check the passivity of following system?

(where $h \in [\alpha_1, \infty]$ and $a > 0, b > 0, \alpha_1 > 0$)

$$\begin{aligned} \dot{x}_1 &= x_2 & \dot{x}_2 &= -h(x_1) - ax_2 + u & y &= bx_2 + u \end{aligned}$$

• Take the storage function $V(x)$ as following form

$$V(x) = \alpha \int_0^{x_1} h(\sigma)d\sigma + \frac{1}{2}\alpha \begin{bmatrix} x_1 & x_2 \end{bmatrix} \begin{bmatrix} p_{11} & p_{12} \\ p_{12} & p_{22} \end{bmatrix} \begin{bmatrix} x_1 \\ x_2 \end{bmatrix} = \alpha \int_0^{x_1} h(\sigma)d\sigma + \frac{1}{2}\alpha(p_{11}x_1^2 + 2p_{12}x_1x_2 + p_{22}x_2^2)$$

• Take time derivative of $V(x)$

$$\begin{aligned} \dot{V} &= \alpha h(x_1)\dot{x}_1 + \alpha(p_{11}x_1\dot{x}_1 + p_{12}x_2\dot{x}_1 + p_{12}x_1\dot{x}_2 + p_{22}x_2\dot{x}_2) \\ &= \alpha h(x_1)x_2 + \alpha(p_{11}x_1 + p_{12}x_2)x_2 + \alpha(p_{12}x_1 + p_{22}x_2)(-h(x_1) - ax_2 + u) \end{aligned}$$

- Take $p_{22} = 1$, $p_{11} = ap_{12}$ and $\alpha = b$, then we have

$$\begin{aligned}
\dot{V} &= b(p_{12} - a)x_2^2 - bp_{12}x_1h(x_1) + (bp_{12}x_1 + bx_2)u \\
&= b(p_{12} - a)x_2^2 - bp_{12}x_1h(x_1) + (bp_{12}x_1 - u + bx_2 + u)u \\
&= b(p_{12} - a)x_2^2 - bp_{12}x_1h(x_1) + (bp_{12}x_1 - u + y)u \\
&= uy - (u^2 - bp_{12}x_1u + \frac{b^2p_{12}^2x_1^2}{4}) + \frac{b^2p_{12}^2x_1^2}{4} - bp_{12}x_1h(x_1) - b(a - p_{12})x_2^2 \\
&= uy - (u - \frac{bp_{12}x_1}{2})^2 + \frac{b^2p_{12}^2x_1^2}{4} - bp_{12}x_1h(x_1) - b(a - p_{12})x_2^2 \\
&\leq uy - bp_{12}(x_1h(x_1) - \frac{bp_{12}x_1^2}{4}) - b(a - p_{12})x_2^2
\end{aligned}$$

- From the sector condition $h \in [\alpha_1, \infty]$, if we use $h(x_1) \geq \alpha_1x_1$, then

$$\begin{aligned}
\dot{V} &\leq uy - bp_{12}(\alpha_1x_1^2 - \frac{bp_{12}x_1^2}{4}) - b(a - p_{12})x_2^2 \\
&\leq uy - bp_{12}(\alpha_1 - \frac{bp_{12}}{4})x_1^2 - b(a - p_{12})x_2^2
\end{aligned}$$

- Take $p_{12} = ak$ with $0 < k < 1$, then we have

$$uy \geq \dot{V} + abk(\alpha_1 - \frac{abk}{4})x_1^2 + ab(1 - k)x_2^2$$

- If we choose $0 < k < \min\{1, \frac{4\alpha_1}{ab}\}$, then the system is strictly passive

9. (Example 5.5) Check the passivity of pendulum system? (where $b \geq 0, c > 0$)

$$\dot{x}_1 = x_2$$

$$\dot{x}_2 = -\sin x_1 - bx_2 + cu$$

$$y = x_2$$

- Take the storage function $V(x)$ as potential plus kinetic energies

$$V(x) = \alpha[(1 - \cos x_1) + \frac{1}{2}x_2^2] \geq 0 \quad \forall x$$

- Take time derivative of $V(x)$

$$\begin{aligned} \dot{V} &= \alpha[\sin x_1 \dot{x}_1 + x_2 \dot{x}_2] \\ &= \alpha[x_2 \sin x_1 + x_2(-\sin x_1 - bx_2 + cu)] \\ &= -\alpha bx_2^2 + \alpha cx_2 u \end{aligned}$$

- Take $\alpha = \frac{1}{c}$, then we have

$$\dot{V} = -\frac{b}{c}y^2 + yu \quad \Rightarrow \quad uy = \dot{V} + \frac{b}{c}y^2$$

- when $b = 0$, the system is passive
- when $b > 0$, it is output strictly passive

(NC) 5.3 Positive Real Transfer Functions (TF)

1. Linear version of the passive system?
2. (Definition 5.4) An $m \times m$ proper rational transfer function matrix $G(s)$ is positive real if

1) all poles of $G(s)$ are in $Re[s] \leq 0$

2) for all real ω for which $j\omega$ is not a pole of $G(s)$, the matrix $G(j\omega) + G^T(-j\omega) \geq 0$

3) any pure imaginary pole $j\omega$ of $G(s)$ is a simple pole and the residue matrix $\lim_{s \rightarrow j\omega} (s - j\omega)G(s)$ is positive semidefinite Hermitian

It is strictly positive real if $G(s - \epsilon)$ is positive real for some $\epsilon > 0$.

3. (Scalar Linear System) when $m = 1$,

$$G(j\omega) + G^T(-j\omega) = 2Re[G(j\omega)] \geq 0 \quad \forall \omega \in [0, \infty)$$

- It means the polar plot (or Nyquist plot) lies in the closed right-half complex plane.
- This condition implies that the relative degree of the transfer function is zero or one b/c the phase is in $[-90^\circ, 0^\circ]$

4. (Example 5.6) Determine whether the system is positive real or not

(a) $G(s) = \frac{1}{s}$

(b) $G(s) = \frac{1}{s+a}$

(c) $G(s) = \frac{1}{s^2 + s + 1}$

- (a) 1) A pole is in $Re[s] \leq 0$. 2) $G(j\omega) + G^T(-j\omega) = 2Re[G(j\omega)] = 0$. 3) $s = 0$ is a simple pole and its residue $\lim_{s \rightarrow j\omega} (s - 0)G(s) = 1$. By Definition 5.4, the system is positive real.

(b) A pole is in $Re[s] \leq 0$. 2) $Re[G(j\omega)] = \frac{a}{\omega^2+a^2} \geq 0$. 3) $s = -a$ is a simple pole and no pure imaginary pole. 4) $G(s - \epsilon) = \frac{1}{s+a-\epsilon}$ is positive real for any $\epsilon \in (0, a)$. By Definition 5.4, the system is strictly positive real.

(c) It is not positive real b/c the relative degree is two.

5. (Lemms 5.1) Let $G(s)$ be an $m \times m$ proper rational TF matrix, and suppose that $\det[G(s) + G^T(-s)]$ is not identically zero. Then $G(s)$ is strictly positive real if and only if

1) $G(s)$ is Hurwitz; that is, poles of all elements of $G(s)$ are in $Re[s] < 0$

2) $G(j\omega) + G^T(-j\omega) > 0 \quad \forall \omega \in \Re$,

3) either $G(\infty) + G^T(\infty) > 0$ or $G(\infty) + G^T(\infty) \geq 0$ and $\lim_{\omega \rightarrow \infty} \omega^{2(m-q)} \det[G(j\omega) + G^T(-j\omega)] > 0$, where $q = rank[G(\infty) + G^T(\infty)]$.

6. (Example 5.6') Determine whether the system is strictly positive real or not

$$(a) \quad G(s) = \frac{1}{s+a} \quad (b) \quad G(s) = \frac{1}{s+1} \begin{bmatrix} s+1 & 1 \\ -1 & 2s+1 \end{bmatrix} \quad (c) \quad G(s) = \begin{bmatrix} \frac{s+2}{s+1} & \frac{1}{s+2} \\ -\frac{1}{s+2} & \frac{1}{s+1} \end{bmatrix}$$

(a) 1) $G(s)$ is Hurwitz with $a > 0$. 2) $Re[G(j\omega)] = \frac{a}{\omega^2+a^2} > 0$. 3) $G(\infty) = 0$ and $m = 1, q = 0$, $\lim_{\omega \rightarrow \infty} \omega^2 |Re[G(j\omega)]| = \frac{a\omega^2}{\omega^2+a^2} = a > 0$. By Lemma 5.1, the system is strictly positive real.

(b) 1) $G(s)$ is Hurwitz. 2)

$$\begin{aligned} G(j\omega) + G^T(-j\omega) &= \frac{1}{j\omega+1} \begin{bmatrix} j\omega+1 & 1 \\ -1 & 2j\omega+1 \end{bmatrix} + \frac{1}{-j\omega+1} \begin{bmatrix} -j\omega+1 & -1 \\ 1 & -2j\omega+1 \end{bmatrix} \\ &= \frac{1}{\omega^2+1} \begin{bmatrix} \omega^2+1 & 1-j\omega \\ -1+j\omega & 2\omega^2+1+j\omega \end{bmatrix} + \frac{1}{\omega^2+1} \begin{bmatrix} \omega^2+1 & -1-j\omega \\ 1+j\omega & 2\omega^2+1-j\omega \end{bmatrix} \\ &= \frac{2}{\omega^2+1} \begin{bmatrix} \omega^2+1 & -j\omega \\ j\omega & 2\omega^2+1 \end{bmatrix} > 0 \end{aligned}$$

3)

$$G(\infty) + G^T(\infty) = \begin{bmatrix} 2 & 0 \\ 0 & 2 \end{bmatrix} > 0$$

By Lemma 5.1, the system is strictly positive real.

(c) 1) $G(s)$ is Hurwitz. 2)

$$\begin{aligned} G(j\omega) + G^T(-j\omega) &= \begin{bmatrix} \frac{j\omega+2}{j\omega+1} & \frac{1}{j\omega+2} \\ -\frac{1}{j\omega+2} & \frac{2}{j\omega+1} \end{bmatrix} + \begin{bmatrix} \frac{-j\omega+2}{-j\omega+1} & -\frac{1}{-j\omega+2} \\ \frac{1}{-j\omega+2} & \frac{2}{-j\omega+1} \end{bmatrix} \\ &= \begin{bmatrix} \frac{2(2+\omega^2)}{1+\omega^2} & \frac{-2j\omega}{\omega^2+4} \\ \frac{2j\omega}{\omega^2+4} & \frac{4}{\omega^2+1} \end{bmatrix} > 0 \end{aligned}$$

3) We know that $m = 2, q = 1, G(\infty) + G^T(\infty) = \begin{bmatrix} 2 & 0 \\ 0 & 0 \end{bmatrix} \geq 0$, and

$$\lim_{\omega \rightarrow \infty} \omega^2 \det[G(j\omega) + G^T(-j\omega)] = \lim_{\omega \rightarrow \infty} \omega^2 \left(\frac{8(2 + \omega^2)}{(1 + \omega^2)^2} - \frac{4\omega^2}{(4 + \omega^2)^2} \right) = 4 > 0$$

By Lemma 5.1, the system is strictly positive real.

7. **(Lemma 5.2) (Positive Real)** Let $G(s) = C(sI - A)^{-1}B + D$ be an $m \times m$ TF matrix where (A, B) is controllable and (A, C) is observable. Then $G(s)$ is positive real if and only if \exists matrices $P = P^T > 0$, L , and $W \ni$

$$PA + A^T P = -LL^T \quad (48)$$

$$PB = C^T - L^T W \quad (49)$$

$$W^T W = D + D^T \quad (50)$$

8. **(Lemma 5.3) (Kalman-Yakubovich-Popov)** Let $G(s) = C(sI - A)^{-1}B + D$ be an $m \times m$ TF matrix where (A, B) is controllable and (A, C) is observable. Then $G(s)$ is strictly positive real if and only if \exists matrices $P = P^T > 0$, L , W , and a positive constant $\epsilon \ni$

$$PA + A^T P = -LL^T - \epsilon P \quad (51)$$

$$PB = C^T - L^T W \quad (52)$$

$$W^T W = D + D^T \quad (53)$$

(proof) Set $\mu = \frac{1}{2}\epsilon$ and recall that $G(s - \mu) = C(sI - \mu I - A)^{-1}B + D$. $G(s - \mu)$ is positive real if $\exists P$ satisfying

$$P(A + \mu I) + (A + \mu I)^T P = -L^T L$$

Hence $G(s)$ is strictly positive real by Definition 5.4

9. (Lemma 5.4) The linear time-invariant minimal realization is

$$\dot{x} = Ax + Bu \quad \text{and} \quad y = Cx + Du \quad \Rightarrow \quad G(s) = C(sI - A)^{-1}B + D \quad (54)$$

- passive, if $G(s)$ is positive real
- strictly passive, if $G(s)$ is strictly positive real.

(proof) Use the storage function $V(x) = \frac{1}{2}x^T Px$. In order to show

$$u^T y \geq \dot{V} + \psi(x)$$

first

$$\begin{aligned} u^T y - \dot{V} &= u^T(Cx + Du) - x^T P(Ax + Bu) \\ &= u^T Cx + \frac{1}{2}u^T(D + D^T)u - \frac{1}{2}x^T(PA + A^T P)x - x^T P Bu \end{aligned}$$

from Lemma 5.3,

$$\begin{aligned} u^T y - \dot{V} &= u^T(B^T P + W^T L)x + \frac{1}{2}u^T W^T W u + \frac{1}{2}x^T L^T L x + \frac{1}{2}\epsilon x^T P x - x^T P Bu \\ &= \frac{1}{2}x^T L^T L x + u^T W^T L x + \frac{1}{2}u^T W^T W u + \frac{1}{2}\epsilon x^T P x \\ &= \frac{1}{2}(Lx + Wu)^T(Lx + Wu) + \frac{1}{2}\epsilon x^T P x \\ &\geq \frac{1}{2}\epsilon x^T P x \end{aligned}$$

- $\epsilon = 0$, the system is passive by Lemma 5.2
- $\epsilon > 0$, the system is strictly passive by Lemma 5.3

(NC) 5.4 Connection with Stability

1. Passive system is stable?
2. Consider the passive system of the form

$$\dot{x} = f(x, u) \qquad y = h(x, u) \qquad (55)$$

where f is locally Lipschitz, h is continuous, $f(0, 0) = 0$ and $h(0, 0) = 0$.

3. (Lemma 5.5) If the system (55) is passive with $V(x) > 0$, then the origin of unforced system $\dot{x} = f(x, 0)$ is stable
4. To show the asymptotically stability of the origin of unforced system $\dot{x} = f(x, 0)$, we need to show that $\dot{V} < 0$ or apply the invariance principle:

$$\dot{V} = 0 \text{ when } y = 0 \quad \Rightarrow \quad y(t) = 0 \quad \Rightarrow \quad x(t) = 0$$

Equivalently, no solution of $\dot{x} = f(x, 0)$ can stay identically in $S = \{h(x, 0) = 0\}$, other than the zero solution $x(t) = 0$.

5. As a matter of fact, above property can be interpreted as an observability condition. Recall that for the linear system

$$\dot{x} = Ax \quad y = Cx$$

observability is equivalent to

$$y(t) = Ce^{At}x(0) = 0 \quad \Rightarrow \quad x(0) = 0 \quad \Rightarrow \quad x(t) = 0 \quad \text{zero-state observable}$$

6. (Definition 5.5) The system (55) is said to be zero-state observable if no solution of $\dot{x} = f(x, 0)$ can stay identically in $S = \{h(x, 0) = 0\}$, other than the zero solution $x(t) = 0$
7. (Lemma 5.6) Consider the system (55). The origin of $\dot{x} = f(x, 0)$ is asymptotically stable if the system is
- strictly passive or
 - output strictly passive and zero-state observable
8. (Example 5.7) Check the stability of m -input and m -output system

$$\dot{x} = f(x) + G(x)u \qquad y = h(x)$$

satisfying

$$\frac{\partial V}{\partial x} f(x) \leq -kh^T(x)h(x) \qquad \frac{\partial V}{\partial x} G(x) = h^T(x) \qquad y(t) = 0 \Rightarrow x(t) = 0$$

for some $k > 0$, where f and G are locally Lipschitz, h is continuous, $f(0) = 0$ and $h(0) = 0$.

- Take the time derivative of $V(x)$

$$\begin{aligned} \dot{V} &= \frac{\partial V}{\partial x} (f(x) + G(x)u) \leq -kh^T(x)h(x) + h^T(x)u = -ky^T y + u^T y \\ u^T y &\geq \dot{V} + ky^T y \end{aligned}$$

thus the system is output strictly passive by Definition 5.3

- In addition, since it is zero-state observable, then the origin of $\dot{x} = f(x)$ is asymptotically stable by Lemma 5.6

9. (Example 5.8) Check the stability of following system

$$\dot{x}_1 = x_2 \qquad \dot{x}_2 = -ax_1^3 - kx_2 + u \qquad y = x_2$$

where a and k are positive constants.

- Take the time derivative of $V(x) = \frac{1}{4}ax_1^4 + \frac{1}{2}x_2^2$

$$\begin{aligned}\dot{V} &= ax_1^3\dot{x}_1 + x_2\dot{x}_2 = ax_1^3x_2 + x_2(-ax_1^3 - kx_2 + u) = -ky^2 + uy \\ uy &= \dot{V} + ky^2\end{aligned}$$

thus the system is output strictly passive by Definition 5.3

- When $u = 0$,

$$\dot{V} = 0 \Rightarrow y(t) = 0 \ (x_2(t) = 0) \Rightarrow \dot{x}_1 = 0 \ \dot{x}_2 = 0 \Rightarrow x_1(t) = 0$$

since it is zero-state observable, then the origin of the unforced system is globally asymptotically stable by Lemma 5.6 b/c the domain can be extended into \mathbb{R}^2 and $V(x) \rightarrow \infty$ as $|x| \rightarrow \infty$

- (HW # 4) solve 5 problems 5.2, 5.7, 5.8, 5.9 and 5.13